



THE GUITAMMER COMPANY INC.

...leaders in low frequency sound...



Feel what you've been missing

Post Office Box 82 / Westerville, Ohio 43082  
info@guitammer.com phone: 888.676.2828 fax: 815.346.9532

## User's Guide

LFE  
**ButtKicker**<sup>®</sup>  
Feel what you've been missing

The Guitammer Company Inc.  
Post Office Box 82 - Westerville, Ohio 43086

Thank you for your purchase of the ButtKicker® LFE, the most powerful, musically accurate and long lasting low frequency audio driver available today.

This User's Guide is designed to help you install and use the ButtKicker in order to receive the most possible enjoyment.

If after following these instructions you are not COMPLETELY THRILLED with the ButtKicker, please contact us. Call, email or fax us. We will do everything possible to make sure you are completely satisfied.

### Specifications.

|                           |                                  |
|---------------------------|----------------------------------|
| Dimensions:               | 5.375" h x 5.5" w                |
| Frequency Response:       | 5 – 200 Hz                       |
| Weight:                   | 11 lbs. / 5 kg.                  |
| Nominal Impedance:        | 4 ohms, inductive                |
| Power Handling:           | 400 watts min. / 1500 watts max. |
| Wiring polarity:          | Red terminal is "Hot"            |
| Thermal Limit (internal): | 150 F. (70 C.)                   |

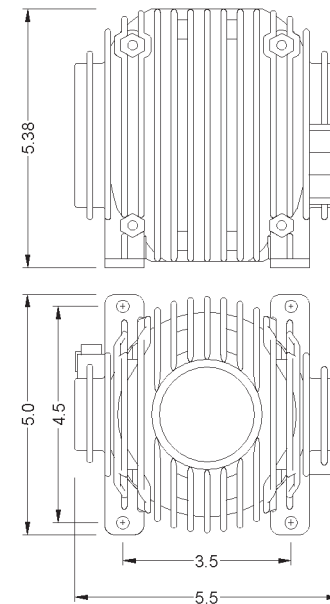

ButtKicker LFE Dimensions  
All measurement in inches

### Contact Information

The Guitammer Company Inc.

PO Box 82

Westerville, OH 43086

support@guitammer.com

Voice: 888-676-2828

Fax: 815-346-9532

Please visit our website [www.thebutt kicker.com](http://www.thebutt kicker.com) for additional technical information, specifications and FAQs.

**Thermal Protection**

If the ButtKicker® is driven too hard (i.e. given too much power for too long of a period) it may overheat. For this reason, each ButtKicker contains a thermal switch. This switch will automatically disconnect the ButtKicker from the amplifier if the internal temperature of the shaker reaches a preset limit. This should happen only rarely, and only when the unit is overdriven. In most situations, the level of "shake" that is produced by the ButtKicker, until it overheats, will be far more than needed. This is also related to the "flexibility" and size of the surface you are endeavoring to shake. However, if tripped, the thermal switch will automatically reset after the unit has cooled sufficiently. Then the ButtKicker will resume normal operation. Cooling off time can be 5 - 20 minutes, depending on ventilation. While in thermal protection mode, the ButtKicker may feel quite warm to the touch, but the cutoff point has been set to avoid damage.

**Warranty**

The Guitammer Company products are warranted against defects in materials and workmanship for a period of two (2) years from date of purchase by the original end-user. Items returned for repair under warranty will be repaired or replaced at the sole discretion of The Guitammer Company without charge for materials or labor, providing such items are returned for inspection, transportation prepaid, to The Guitammer Company or an authorized service center. All repaired or replaced items will be returned freight collect. Warranties do not apply to products that have been subjected to abuse, accident, modifications, improper handling or installation, or repairs made by anyone other than The Guitammer Company or an authorized service center. The Guitammer Company shall be the final authority in the determination of all warranty service claims.

*Please contact us before returning any defective products to the store where they were purchased.*

- Product Description ..... 1
- Quick Setup ..... 2
- Integration into Your Sound System ..... 3
  - Power ..... 3
  - Low End Roll Off ..... 3
  - Source Material ..... 3
- Source Hookup to Amplifier ..... 4
  - Surround Sound System ..... 4
  - Gaming Consoles / Stereo Systems ..... 4
  - No "Subwoofer Output" ..... 5
- Physical Mounting and Placement ..... 5
- Mounting Considerations ..... 6
  - General ..... 6
  - Floating Wood Floors ..... 8
  - Chairs and Couches ..... 8
  - Platforms and Risers ..... 8
  - How to Determine How Many Isolators You Will Need.... 10
  - Vertical vs. Horizontal Mounting..... 10
- Thermal Protection ..... 11
- Warranty ..... 11
- Specifications ..... 12
- Contact Information..... 12

### Product Description

The ButtKicker® LFE is a patented 4 ohm low frequency audio transducer that features a 3<sup>1/4</sup> lb. (1.48 kg) magnetically suspended piston. The ButtKicker is musically accurate, has powerful low frequency response, and is virtually indestructible and maintenance free. With a natural working range of approximately 5-200Hz, it is designed primarily to move structure, not air, and to provide a much more direct method of sound perception. Because it provides a more effective sense of feeling than that produced by the speaker system, the ButtKicker enables your subwoofer and speaker system to function in their more natural, audible working ranges. Many users wind up turning the sound system down when using the ButtKicker, reducing the amount of sound that their significant others, family, friends and neighbors hear outside of the theater area. For this reason, the ButtKicker is an ideal solution for connected housing, such as apartments. We like to call it, "spouse and neighbor friendly".

*For musician monitoring, stage and studio use, we recommend using the ButtKicker® Concert which has more power in the 40 – 80 Hz range than the ButtKicker® LFE. Please refer to our website, [www.thebuttkicker.com](http://www.thebuttkicker.com) for further information.*

### How to Determine How Many Isolators You Will Need

Rubber isolators come in different weight capacities. Isolators are designed to be partially compressed in application and therefore are made with varying weight specifications. This specification (RDA-55, RDB-120, RDB-220, RDB-375) indicates the amount of weight in lbs. that each isolator is designed to support (per isolator) for greatest efficiency.

When used with furniture, a platform, or a riser, calculate the total weight to be carried by the isolator, including the weight of the platform, furniture and people. Divide this weight by the total number of isolator feet to be used (i.e. a minimum of 3, a usual number of 4, more only when necessary). This will give you the weight per isolator. Pick the isolator model closest to your calculated weight.

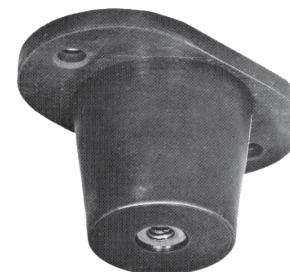

Figure 8. Kinetics Rubber Isolator

### Vertical vs. Horizontal Mounting

The ButtKicker was designed for optimal performance in the vertical orientation, but will function at any angle. Movement sensation is very different in the two axis, and only when specific sensations are required should horizontal mounting be utilized. Horizontal orientation will not damage the ButtKicker.

*Please note that vertical installation is strongly recommended in when mounting in chairs and other types of furniture.*

needed under the riser. As always, keep in mind any maintenance that may become necessary.

Think “suspension.”

In essence, you’re constructing a floor above the room’s floor. Build the riser similar to a suspended wood joist floor to give the riser its greatest low frequency response.

The major differences between a riser and real floors are the suspension points and tie points (to other external structure). The riser should be free floating (not tied into any adjacent walls), and suspended by short sides only. Use rubber isolators on the short dimension to support the riser from the room floor.

The greatest flex of the riser will be along its long dimension, the riser’s short dimension will offer much less low frequency flexibility. Therefore, when possible, avoid any support along the long dimension.

### Quick Setup

This section is for those who are more experienced with sound system installation. The ButtKicker® is a passive, 4 ohm speaker load, which requires power from an audio power amplifier, which in turn requires an adequate signal feed from your sound system (Figure 1). Shaking forces are produced in the direction of the axis of the shaker as shown (Figure 2). A positive voltage at the red terminal wire will produce a “push” by the ButtKicker toward its feet (red terminal is positive). It can be mounted on the topside of a surface or inverted and mounted to the bottom side of a surface.

*It may also help you to consider the ButtKicker as a “mechanical” powered subwoofer that enables you to “feel” the low end (bass) by vibrating the surface to which it is attached as opposed to moving air like a subwoofer. And, like a powered subwoofer, the ButtKicker also requires a separate amplifier to power it. While powered subwoofers have their amplifiers in the speaker cabinet, the ButtKicker’s amplifier is a separate component because the ButtKicker is typically mounted in, beneath or on what it shakes, typically not an appropriate place for an amplifier.*

Additional details are provided in the following sections.

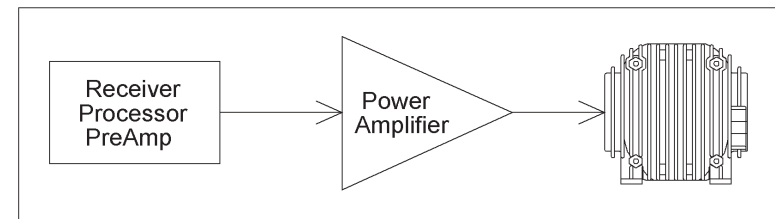

Figure 1. System Integration

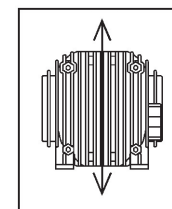

Figure 2. Shake

## Integration into Your Sound System

### Power

The ButtKicker® is a passive load and therefore requires its own dedicated audio power amplifier. Suggested minimum required power is 400 watts. The use of 14 gauge speaker cable between the amplifier and the ButtKicker is recommended. For cable runs over 25 feet, 12 gauge speaker cable is recommended.

### Low End Roll Off

When choosing a power amplifier other than the ButtKicker Power Amplifier (BKA1000-4), please be aware of the low frequency response of the amplifier. Many manufacturers roll off, or cut frequencies below 20 Hz, usually because anything below 20 Hz has been considered unusable and damaging for speaker systems. Therefore, amplifier manufacturers often include additional circuitry to reduce or eliminate those damaging "unusable" signals before they are amplified and sent to the speaker. This roll off of low frequencies (also called "Low Cutoff" or "Hi Pass" filters) is not best for the ButtKicker, although a shallow roll off can be tolerated (i.e. -1.5 dB to -3 dB at 10 Hz). A full cut at 20 Hz and below is not acceptable because it will severely limit some of the remarkable qualities of the ButtKicker. You should find frequency response listed among the amplifier manufacturer's specifications.

### Source Material

The ButtKicker responds to a broad range of bass frequencies, including those far below what we hear, or deep down into the feeling range of sound. Today's digital sound sources (DVD's, MP3's, etc.) are capable of carrying signals down to 5 Hz, but it is the producers who determine the content of a sound track. Therefore, the level and range of bass contained within any given sound track will vary. Even though a DVD may show the launch of a rocket, the audio track will contain only what the producers chose to include in the audio track. The ButtKicker responds accurately to the existing low frequency content, much as a subwoofer responds to the signal given it.

## Floating Wood Floors

The surface below you is your physical connection to your environment. A suspended, joist floor is an ideal mounting surface for the ButtKicker®. Best results are obtained by installing two 2" x 6" boards between two floor joists (Figure 6). Place them near the center of the room, or near the seating area of the audience, avoiding any supports and bracing that would not allow the floor to move. Then mount the ButtKicker to the two 2" x 6" boards.

An alternative method is shown in Figure 7. Here, a 2" x 6" board is attached broadside across the bottom edge of three joists.

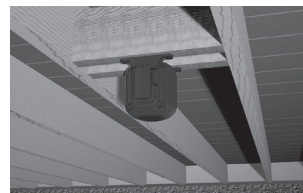

Figure 6

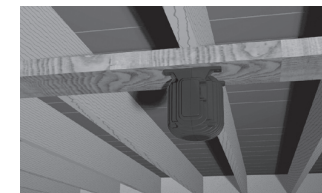

Figure 7

## Chairs and Couches

When properly installed to your couch or chair the ButtKicker will provide excellent low frequency sound reproduction without excessive midrange vibrations. If possible, we recommend using rubber isolators on the bottom of your furniture's legs (or as a replacement for the legs) to better isolate the furniture from the floor.

## Platforms and Risers

Many home theaters have more than one row of seats, with the second and third rows built upon risers. These risers, for ButtKicker applications, have two purposes: raise and support the seats and occupants, and allow vertical platform and seat movement.

The ButtKicker can be mounted above or below the top surface of the riser. If above, consider people traffic and furniture placement. If under the surface, some simple framing can be done to avoid the extra room



## What does shake, cont.

### Example one

A room with a suspended, joist floor measuring 12' by 14'. The floor is only supported around the edges (at the walls) by a foundation, and is capable of bending and vibrating in the area between its supported hard points. This is similar to a guitar string that can vibrate between its supporting hard points at each end of the string. This floor would be best shaken by a ButtKicker® mounted to the floor in the center area of the room away from the dampening action of the walls.

### Example two

A room, similar in size to the room of Example one, but this construction is different in that the floor has additional support underneath, made up of a pier or foundational wall that runs under the floor about 5 feet from one of the room's walls. The floor is now supported at an additional point, which effectively divides the floor into two suspended sections measuring 12' by 5', and 12' by 9'. This effect would be similar to placing a finger on a guitar string, holding the string against a fret. This floor will vibrate in a different manner than that of Example one. The 12' by 5' section will not allow as much bending of the floor's materials between its supports (hard points) and will therefore exhibit less low frequency shaking than the 12' by 9' section. (For example, a higher note on a guitar string.)

As an additional note, if the wider section of this floor were shaken with the ButtKicker, the narrower section would still exhibit some "sympathetic" and less pronounced vibrations because of its connection to the wider section of the floor.

### Example three

A room with a concrete slab floor, lying directly on the earth. This floor will be practically impossible to shake. In your main listening area, your favorite couch is the best option. The feet at the ends of the couch are pressed and held firm against the concrete slab by its weight and are therefore unmoving hard points of the couch. The horizontal length of the couch between the feet is suspended and will bend and shake but only to the degree allowed by its materials and construction. See the "chairs and couches" section for more information.

## Source Hookup to Amplifier

### Surround Sound System

One signal source for the ButtKicker® is the "Subwoofer" output of your surround receiver/processor. This output is controlled by the master volume control and usually a separate subwoofer control. If a subwoofer is also a part of the sound system and connected to this signal output, then a "Y" cable may be used to split the signal two ways (Figure 3-C).

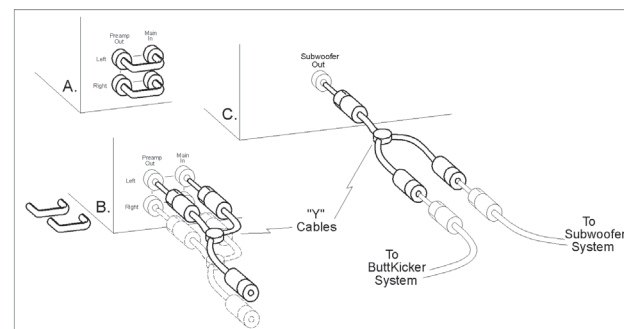

Figure 3-C

### Gaming Consoles/Stereo System

The ButtKicker also works well in a two channel, stereo system and with gaming consoles like Microsoft's XBOX®, Sony's PlayStation® 2 and Nintendo's GameCube™. In a two channel stereo system, the low frequency signals are very seldom only on the left or right channel, so a connection to either left or right channel preamp output would produce satisfying results (Figure 3-B).

#### A further note about gaming consoles:

*The XBOX®, PlayStation® 2 and GameCube™ all have digital out capabilities that enable the console to connect to a surround sound (5.1, 6.1, etc.) system. Many new games feature 5.1 digital sound with a .1 or LFE track that is ideal for use with the ButtKicker. If you connect your gaming console to a surround sound processor then the ButtKicker will connect to the system using your processor's "subwoofer out" as described in the preceding "Surround Sound System" section.*

### No Separate "Subwoofer Output"

If no "Subwoofer Output" exists on your processor / receiver / preamp please visit our website, [www.thebuttkicker.com](http://www.thebuttkicker.com), or contact our technical support department.

### Physical Mounting and Placement

Some consideration regarding the human sense of feeling: Your brain is constantly making perceptions of your surroundings- indoors or outdoors, size, shape and material of a room, etc. Your brain and body have been doing this with all of your senses since the day you were born, confirming and associating what it hears with what it sees, feels, tastes and smells.

You probably at some time have become aware of something or someone by seeing a shadow it cast within your view (its effect on your environment) rather than seeing the item itself. Have you ever "sensed" someone enter the room without them making a sound? You were unconsciously aware of a change in the room's sound characteristics associated by your mind with the addition of another person. Your brain and body have "perceived" this many times before, whether you are consciously aware of it or not. Your body also knows more about its surroundings via the sense of feel than you probably realize. The field of entertainment has come great distances to capture your senses of hearing and seeing, and the next major sense to "capture" is your sense of feeling.

Our bodies feel sound through both air (momentary changes in air pressure) and structure (i.e. the ground or floor on which we stand). The speaker system supplies the air vibrations and pressure changes we hear and feel in the air. The ButtKicker supplies the structural vibrations.

### Mounting Considerations

#### General

The best way to understand the movement or shaking potential of any structure is to first identify areas that will NOT shake: (see Figure 5)

- The earth will not shake. While this is not an absolutely true statement, it is a very practical statement, and for the purposes of this User's Guide it will be considered an absolute. (#1 in Figure 5)
- Any hard support or structure that vertically ties a surface to earth defines a secondary "hard point;" a point not allowed to shake by virtue of its connection to the earth. For example, a supporting wall, concrete slab, building foundation, pier, or column (#2 in Figure 5).

What DOES shake:

- Any horizontal structure suspended between two or more hard points will flex, bend and shake between those hard points, depending on the construction and rigidity of the suspended structure. For example, a wood joist floor or a couch between its legs (#3 in Figure 5).

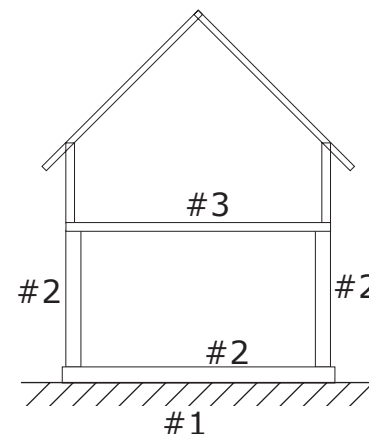

Figure 5